

# LCAT22

2' x 2' LED CONTEMPORARY ARCHITECTURAL TROFFER

DATE:	LOCATION:
TYPE:	PROJECT:
CATALOG #:	

## FEATURES

- High efficiency acrylic center lens features linear prisms for high performance without pixelation
- Appropriate for offices, schools, medical, and public spaces
- High performance reflector with matte white paint standard
- LED modules and electrical accessible from below
- Optional architecturally styled integration of daylight and occupancy sensor(s)
- QR code traceability
- Compatible with Dual-Lite inverters



## CONTROLS TECHNOLOGY



## SPECIFICATIONS

### CONSTRUCTION

- Luminaire housing, reflectors and end caps are die-formed code-gauge cold-rolled steel
- High transmission extruded acrylic enclosed lens features linear prisms with custom frost for high efficacy without pixelation
- All reflective surfaces are finished after fabrication with unique formula high-reflectivity matte white paint for soft, uniform indirect illumination

### OPTICS

- Removable lens for easy access to LED module and electrical components

### INSTALLATION

- An access plate is furnished with each luminaire for fast wiring access without the necessity to open the fixture or wireway
- Luminaire fits recessed exposed Grid ceilings (G); four integral NEC compliant T-bar clips are standard
- Can be placed in Slot Grid (SG) style ceiling with regress 3/8" above ceiling plane
- A Flange Kit (FK) accessory is available for recessed hard ceiling applications
- Surface Mount (SM) option allows placement below ceiling plane
- Cable Mount (CM) option allows suspension below ceiling plane

### ELECTRICAL

- 60,000 hour LEDs at L80 for reduced maintenance

### ELECTRICAL (CONTINUED)

- 83 CRI standard or optional 90 CRI for color sensitive applications

### CONTROLS

- Optional SpectraSync™ offers two modes of Tunable White solutions and integrates seamlessly into a variety of control systems
- NX Lighting Controls provides options for standalone and networked integrated sensor with wired or wireless connectivity for NX system deployments

### CERTIFICATIONS

- IC label is standard for recessed products. Note that IC label is void if product is installed on site with a combination of both battery pack plus through wiring or for air return fixtures
- All luminaires are built to UL1598 and 2108 standards, and bear appropriate cCSAus labels
- CSA certified to UL 924 standards with battery pack or DTS (Dimming Bypass Module) options
- Damp Location label standard
- Adheres to LM79, LM80, and TM21 industry standards
- DLC® (DesignLights Consortium) Qualified, with some Premium Qualified configurations. Please refer to the DLC website for specific product qualifications at [www.designlights.org](http://www.designlights.org)

### CERTIFICATIONS (CONTINUED)

- NX is available in U.S., Canada and Mexico. For other locations consult factory
- The DTS, Dimming Bypass Module, is for emergency circuit control loads including sensors and wireless systems CSA certified to UL 924. See page 8 for wiring diagram.
- This product qualifies as a "designated country construction material" per FAR 52.225-11 Buy American-Construction Materials under Trade Agreements effective 04/03/2020.

### WARRANTY

- 5 year warranty

KEY DATA	
Lumen Range	1510–4794
Wattage Range	12–35
Efficacy Range (LPW)	121–141
Reported Life (Hours)	L80/60,000

**LCAT22**

2' x 2' LED CONTEMPORARY ARCHITECTURAL TROFFER

DATE:	LOCATION:
TYPE:	PROJECT:
CATALOG #:	

**ORDERING GUIDE**

Example: LCAT22-35MLG-ESDU

CATALOG #

LCAT22								
Model	CRI	Color Temp	Delivered Lumens	Ceiling Type	Shielding	Air Function	Driver <sup>18</sup>	
LCAT22 2' x 2' LED Contemporary Architectural Troffer	Blank	>80	30 3000K	VW 1510-1681	G Grid Lay-in <sup>2</sup>	Blank	Blank	E Fixed Output
	9	>90	35 3500K	MW 1998-2253	SM Surface Mount <sup>3,11</sup>	Curve	A	ED 0-10V Dimming <sup>5</sup>
			40 4000K	LW 2581-2903	CM Cable Suspended Mount <sup>3,4</sup>	Rectangular	Static	ED1 0-10V 1% Dimming
			50 5000K	ML 3141-3532			Air Return Side Slots	EDD 0-10V Dim-to-Dark
			2750T 2700K-5000K SpectraSync™ Tunable White <sup>1</sup>	HL 4056-4286				ESD Step Dimming <sup>6,7,12</sup>
		2765T 2700K-6500K SpectraSync™ Tunable White <sup>1</sup>	VL 4253-4794				LUTH Hi-lume 1% EcoSystem LED driver with Soft-on, Fade-to-Black dimming technology <sup>6,7,12</sup>	
							DALIP DALI Power Bus <sup>7,12,15</sup>	

Voltage	Options	Control Options
U 120-277V 347 347V <sup>13</sup>	<p><b>ELL14</b> Emergency Battery Pack Installed, 1400 Lumens<sup>7,8</sup></p> <p><b>ELL14ST</b> Emergency Battery Pack, 1400 Lumens, Self Test<sup>7,8</sup></p> <p><b>ELL14H2</b> Emergency Battery Pack, 2-Hour Run Time<sup>7,8,9</sup></p> <p><b>DTS</b> Dimming Bypass Module<sup>7,10</sup></p> <p><b>C388</b> 3-wire Flex<sup>14</sup></p> <p><b>C488</b> 4-wire Flex<sup>14</sup></p> <p><b>C588</b> 5-wire Flex<sup>14</sup></p> <p><b>GLR</b> Fast Blow Fuse</p> <p><b>EOR</b> End of Row (SM and CM only. Provides end wiring access for continuous row mounting.)<sup>3</sup></p> <p><b>INT</b> Intermediate (SM and CM only. Provides ends with wiring access for continuous row mounting.)<sup>3</sup></p> <p><b>CP</b> Chicago Plenum</p>	<p><b><u>NX Networked – Wired</u></b></p> <p><b>NXE</b> NX Wired Dual RJ45 SmartPORTS, without Sensor<sup>12,13</sup></p> <p><b>NXESM</b> NX Wired Dual RJ45 SmartPORTS and Integral NXSMP2-SMI PIR Occupancy Sensor with Automatic Dimming Photocell and Bluetooth Programming<sup>12,13</sup></p> <p><b><u>NX Networked – Wireless</u></b></p> <p><b>NXW</b> NX Networked Wireless Radio Module NXRM2 and Bluetooth Programming, without Sensor<sup>11,12,13</sup></p> <p><b>NXWSM</b> NX Networked Wireless Enabled Integral NXSMP2-SMI PIR Occupancy Sensor with Automatic Dimming Photocell and Bluetooth Programming<sup>11,12,13</sup></p> <p><b><u>Third-Party Control Options</u></b></p> <p><b>ODPG</b> Occupancy and Daylight Sensors w/ Grouping, Philips SNS200<sup>7,15,17</sup></p> <p><b>LVR</b> Lutron Vive Integral Fixture Control DFCSJ-OEM-RF (RF only)<sup>7,15,16,17</sup></p> <p><b>LVS</b> Lutron Vive Integral Fixture Control DFCSJ-OEM-OCC (RF with daylight and occupancy sensing)<sup>7,15,16,17</sup></p>

- Accessories**
- FK22** 2' x 2' Single Flange Kit (Shipped separately)
  - CM48Y2SC3F-KIT** 48" Cable Mount Kit for 2' wide Cable Mount fixtures, 3-wire

Notes:

- Available with ED driver and 80 CRI only. Not available with VL lumen output
- For drywall, order G with Flange Kit Accessory
- Not available with Air Return (A) air function
- Order hanger accessories separately
- 1V minimum low-end trim recommended when paired with a 0-10V dimmer
- Limitations apply based on lumen packages (see Product Exceptions & Details)
- Not available in 347V
- For compatibility with Dual-Lite LiteGear® inverters, contact Lighting Representative
- Not available for use in Canada
- For emergency circuit control loads including sensors and wireless systems CSA certified to UL 924. Only available with 0-10V drivers. Universal voltage only. See page 8 for wiring diagram

**NX In-Fixture Control Options:**

- NXSW, NXWE, NXSWD and NXWD cannot be used with surface mount versions
- NX is not available with ESD, LUTH, or DALIP driver options
- NX combined with Spectrasync is not available in 347V
- For NX control and Flex Wire together, consult factory

**Third-Party Control Options**

- LVS, LVR and ODPG only available with DALIP driver option
- VIVE is a trademark of Lutron Electronics Co., Inc
- Not available with SpectraSync (2750T or 2765T)

**Dimming Notes**

- Dimming curves may vary; dependent upon lumen output and driver option chosen. Separate dimming circuits are recommended if multiple driver options are chosen.

For questions about configuration options, contact Lighting Representative

DATE:	LOCATION:
TYPE:	PROJECT:
CATALOG #:	

**PRODUCT EXCEPTIONS & DETAILS**

Driver options listed below are available for the outputs as shown.

DRIVER AVAILABILITY TABLE						
	VW	MW	LW	ML	HL	VL
E	X	X	X	X	X	X
ED	X	X	X	X	X	X
ED1	X	X	X	X	X	X
EDD		X	X	X	X	
ESD			X	X	X	X
LUTH		X	X	X		
DALIP	X	X	X	X	X	X
347	X	X	X	X	X	X

**CONTROLS**

**NX Lighting Controls:**

Supports both indoor and outdoor applications in a variety of deployment options- wired, wireless, hybrid. Integrates with and enables a wide array of luminaires including those with SpectraSync™ Color Tuning Technology.



NX INTEGRATED CONTROLS REFERENCE								
NX Option	Sensor	Networkable	Scheduling	Occupancy	Daylight Harvesting	0-10V Dimming	On/off Control	Bluetooth® App Programming
<b>NX Networked – Wired</b>								
NXE	N/A	Yes	Yes	No	No	Yes	Yes	Requires NXBTC/R <sup>1</sup>
NXESM	NXSMP2- SMI-XX	Yes	Yes	Yes	Yes	Yes	Yes	Yes
NXERM	NXSMP2-LMI	Yes	Yes	Yes	Yes	Yes	Yes	Yes
<b>NX Networked – Wireless</b>								
NXWSM	NXSMP2- SMI-XX	Yes	Yes	Yes	Yes	Yes	Yes	Yes
NXW	N/A	Yes	Yes	No	No	Yes	Yes	Yes

1 NXBTC/R needs to be plugged into an available NX SmartPORT™ on the fixture network  
 2 To program NXWE option, need to consult factory. If connected to an area controller, programming can be done from that

**Philips EasySense Controls ODPG Sensor:**



- Occupancy sensing, daylight harvesting, task tuning and grouping in one device
- Standalone control or grouping to wireless switches<sup>1</sup>
- Uses Philips field apps for on site commissioning<sup>2,3</sup>
- Ability to create scenes for various room configurations
- Cost-effective solution for energy-savings and code-compliance strategies
- DLC® Qualified: Listed on the GPL for Networked Lighting Controls. Please refer to the DLC website for specific product qualifications at [www.designlights.org](http://www.designlights.org)

1 Wireless switches only compatible with ODPG Philips EasySense  
 2 Requires android device or IR dongle.

**Wireless Switch Accessories<sup>1</sup>**

- PESR-WH EasySense compatible wireless single rocker switch, white
- PEDR-WH EasySense compatible wireless dual rocker switch, white

DATE:	LOCATION:
TYPE:	PROJECT:
CATALOG #:	

**SpectraSync™ Color Tuning Technology:**

Control your space based on the needs of the application, specific activities throughout the day and preferences of the occupants with distinct SpectraSync™ Color Tuning Technologies.



SPECTRASYNC COLOR TUNING TECHNOLOGY		
Mode	Kelvin Range	Description
Tunable White	2700K–5000K 2700K–6500K	Offers users the ability to tailor CCT to their personal preference, enhancing task visibility, material and colors or the aesthetics of the space

**SpectraSync Tunable White**

Available in two options: 2750T (2700K–5000K) or 2765T (2700K–6500K). Requires two 0–10V controllers, one for intensity and one for CCT. Minimum 5% dimming.

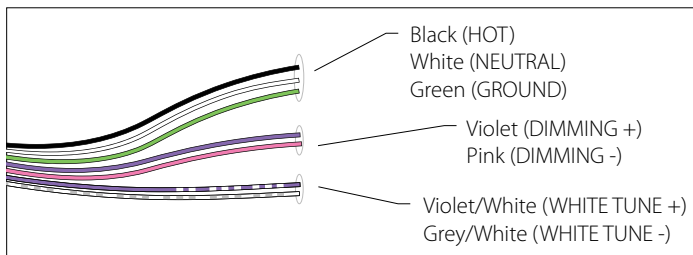

SpectraSync Tunable White luminaires are provided with two 0–10V circuits. The violet and pink circuit is for wiring to any qualified 0–10V controller for dimming. The violet/white and grey/white circuit is for wiring to any qualified 0–10V controller for Tunable White CCT control.

**Controller Manufacturer Data**

SpectraSync Tunable White was designed to be used with sinking style dimmers (provided by others) and is compatible with:

- NX Lighting Controls Room Controller (NXRC) and In-fixture Controllers (NXFM)
- Lutron: DDTV, DVSTV, and NFTV dimmers
- Wattstopper: ADF120277 and CD4BL (Titan) dimmers

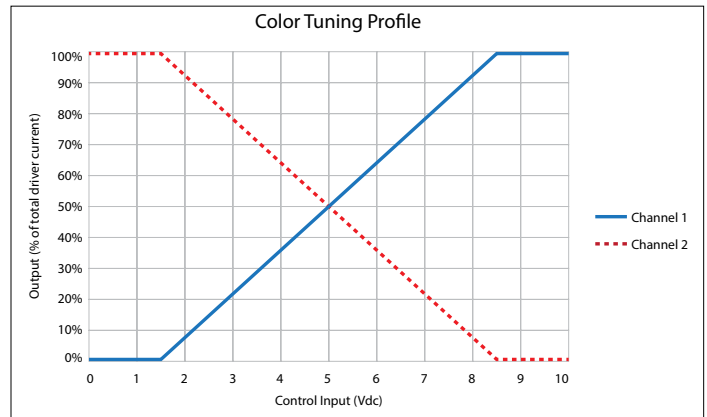

To enable scheduling and for use with NX wall control preset stations please refer to NX SpectraSync technical sheet.

**DELIVERED LUMENS, SPECTRASYNC™**



Shielding	Lumen Output	Watts	2700		3000		3500		4000		5000		6500	
			Lumens	LPW	Lumens	LPW	Lumens	LPW	Lumens	LPW	Lumens	LPW	Lumens	LPW
Curve	VW	14	1500	110	1567	115	1595	117	1616	119	1669	123	1644	121
	MW	18	1961	109	2049	114	2086	116	2113	117	2182	121	2149	119
	LW	23	2582	114	2698	119	2747	122	2782	123	2873	127	2830	125
	ML	29	3177	111	3320	116	3380	118	3423	119	3536	123	3483	121
	HL	32	3444	108	3599	113	3664	115	3711	117	3833	121	3775	119
Rectangle	VW	13	1479	110	1545	115	1573	117	1593	119	1645	123	1621	121
	MW	18	1930	109	2017	114	2053	116	2080	117	2148	121	2116	120
	LW	23	2547	113	2661	118	2709	120	2743	121	2834	125	2791	124
	ML	29	3127	109	3267	114	3326	116	3368	117	3479	121	3427	119
	HL	32	3391	107	3543	112	3607	114	3653	116	3773	119	3717	118

# LCAT22

2' x 2' LED CONTEMPORARY ARCHITECTURAL TROFFER

**DELIVERED LUMENS** (View 90 CRI data on supplemental document)

Product Availability 80 CRI					
Lumen Package	Shielding	Color	Lumens	Input Watts	LPW
VW		3000K	1561	12.3	127
		3500K	1663	12.3	135
		4000K	1681	12.3	137
		5000K	1681	12.3	137
	R	3000K	1510	12.3	123
		3500K	1609	12.2	132
		4000K	1627	12.2	133
		5000K	1627	12.2	133
MW		3000K	2099	16.4	128
		3500K	2229	16.4	136
		4000K	2253	16.4	138
		5000K	2253	16.4	138
	R	3000K	1998	16.4	122
		3500K	2121	16.4	129
		4000K	2144	16.4	131
		5000K	2144	16.4	131
LW		3000K	2705	20.6	131
		3500K	2871	20.6	139
		4000K	2903	20.6	141
		5000K	2903	20.6	141
	R	3000K	2581	20.6	125
		3500K	2740	20.6	133
		4000K	2770	20.6	134
		5000K	2770	20.6	134
ML		3000K	3291	25.8	127
		3500K	3494	25.8	135
		4000K	3532	25.8	137
		5000K	3532	25.8	137
	R	3000K	3141	25.9	121
		3500K	3334	25.9	129
		4000K	3371	25.9	130
		5000K	3371	25.9	130

Product Availability 80 CRI (continued)					
Lumen Package	Shielding	Color	Lumens	Input Watts	LPW
HL		3000K	4196	33.5	125
		3500K	4239	33.1	128
		4000K	4286	33.1	129
		5000K	4286	33.1	129
	R	3000K	4056	33.5	121
		3500K	4100	33.1	124
		4000K	4146	33.1	125
		5000K	4146	33.1	125
VL		3000K	4468	35.1	127
		3500K	4741	35.1	135
		4000K	4794	35.1	136
		5000K	4794	35.1	136
	R	3000K	4253	35.2	121
		3500K	4513	35.2	128
		4000K	4564	35.2	130
		5000K	4564	35.2	130

**LCAT22**

2' x 2' LED CONTEMPORARY ARCHITECTURAL TROFFER

DATE: \_\_\_\_\_ LOCATION: \_\_\_\_\_

TYPE: \_\_\_\_\_ PROJECT: \_\_\_\_\_

CATALOG #: \_\_\_\_\_

**DIMENSIONS**

**GRID**

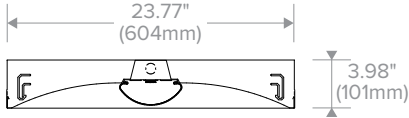

**Grid, recessed section**

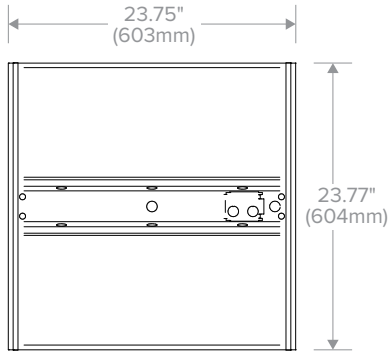

**Grid, back of housing**

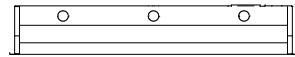

**GRID, STATIC**

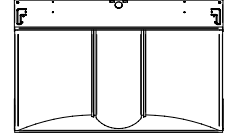
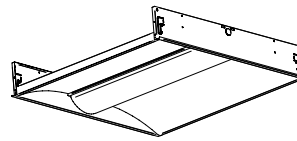

**GRID, AIR RETURN**

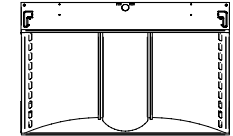
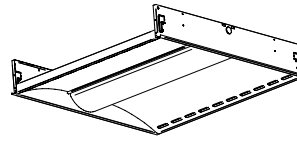

**CEILING COMPATIBILITY**

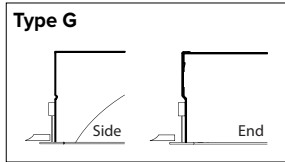

For lay-in installation in exposed grid ceilings. Maximum tee widths of 1" and maximum tee heights of 2" allowed.

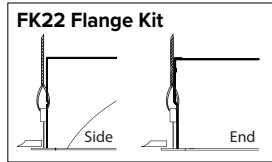

For hard ceiling applications, order FK22 flange kit. Flange kit wires directly into concealed ceiling opening for a clean, finished appearance.

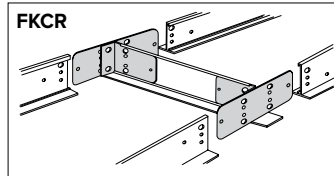

For flanged fixtures in row configurations, the FKCR adapter bracket kit is required in addition to the FK22 kit. Order one less FKCR than the total number of fixtures in row. (Example: Row of two, order (2) FK22 & (1) FKCR)

Row cut out dimensions using FK22s & FKCR adapters: Width 24 3/8", Length [24" x (# in row)] + 3/8". Example: (24" x 2) + 3/8" = 48 3/8"

**Flange kit cut out dimension for single unit only: 24 3/8" x 24 3/8"**

**SURFACE MOUNT OR CABLE MOUNT, STATIC ONLY**

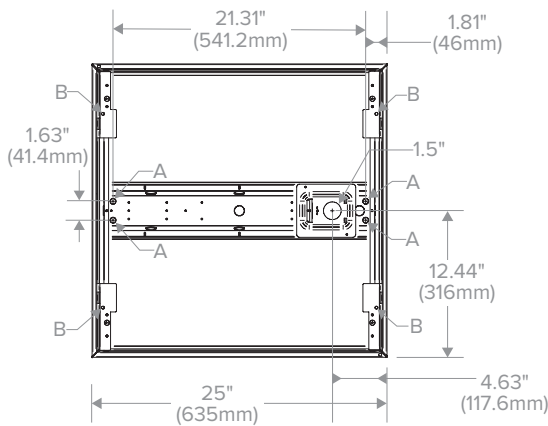

**Surface Mount (SM) and Cable Mount (CM), back of housing**

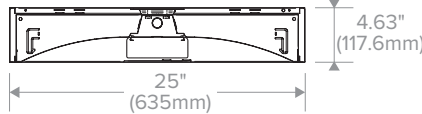

**Surface section (SM)**

**Surface Mount:**

Order SM ceiling type. Mounting collar required for surface mounting. (4) Mounting knock-outs, 3/8", provided in center channel as indicated at left, marked A.

**Cable Mount:**

Order CM ceiling type. Use CM48Y2SC3F-KIT 48" Cable Mount Kit for 2' wide CM trim fixtures. Mounting holes are provided in diagonal straps shown at left, marked B.

\* For Cable Mount a 2' x 3" access plate with (4) 3/8" KOs provided in place of Mounting Collar shown.

**NOTE:** All dimensions are in inches; dimensions and specifications are subject to change without notice. Please consult factory or check sample for verification.

# LCAT22

2' x 2' LED CONTEMPORARY ARCHITECTURAL TROFFER

DATE: \_\_\_\_\_ LOCATION: \_\_\_\_\_

TYPE: \_\_\_\_\_ PROJECT: \_\_\_\_\_

CATALOG #: \_\_\_\_\_

## PHOTOMETRY

### LCAT22-35LWG-EU

#### LUMINAIRE DATA

Test No.	16540
Description	2' x 2' LED architectural troffer with frosted linear prisms lens
Delivered Lumens	2769
Watts	22.60
Efficacy	123
Mounting	Recessed
Spacing Criterion	0° = 1.19 90° = 1.31

#### ZONAL LUMEN SUMMARY

Zone	Lumens	% Luminaire
0-30	705	25.5
0-40	1154	41.7
0-60	2056	74.3
0-90	2769	100
0-180	2769	100

#### POLAR GRAPH

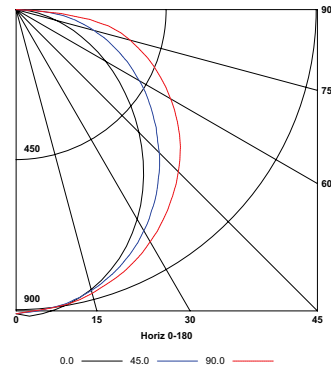

### LCAT22-35MLG-EU

#### LUMINAIRE DATA

Test No.	16543
Description	2' x 2' LED architectural troffer with frosted linear prisms lens
Delivered Lumens	3420
Watts	28.70
Efficacy	119
Mounting	Recessed
Spacing Criterion	0° = 1.19 90° = 1.31

#### ZONAL LUMEN SUMMARY

Zone	Lumens	% Luminaire
0-30	871	25.5
0-40	1424	41.7
0-60	2539	74.2
0-90	3420	100
0-180	3420	100

#### POLAR GRAPH

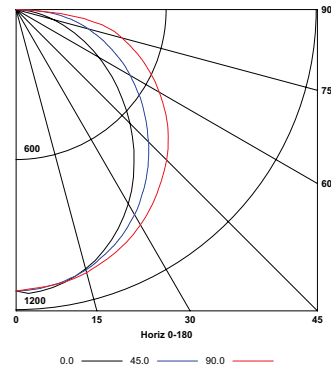

### LCAT22-35HLG-EU

#### LUMINAIRE DATA

Test No.	16546
Description	2' x 2' LED architectural troffer with frosted linear prisms lens
Delivered Lumens	3707
Watts	31.80
Efficacy	117
Mounting	Recessed
Spacing Criterion	0° = 1.19 90° = 1.31

#### ZONAL LUMEN SUMMARY

Zone	Lumens	% Luminaire
0-30	943	25.4
0-40	1543	41.6
0-60	2751	74.2
0-90	3707	100
0-180	3707	100

#### POLAR GRAPH

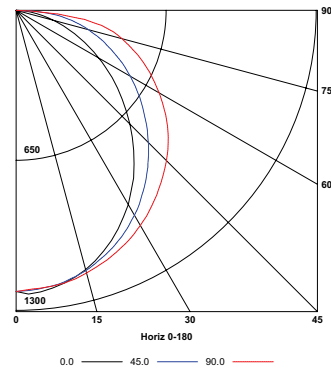

## ADDITIONAL INFORMATION

### DTS WIRING DIAGRAM (0-10V DIMMING DRIVER SHOWN)

